

Technical data sheet



Product features

Open stand mobile

Model

SAP Code

00003160



– Material: Stainless steel

Technical data sheet



Technical drawing

Open stand mobile

Model

SAP Code

00003160

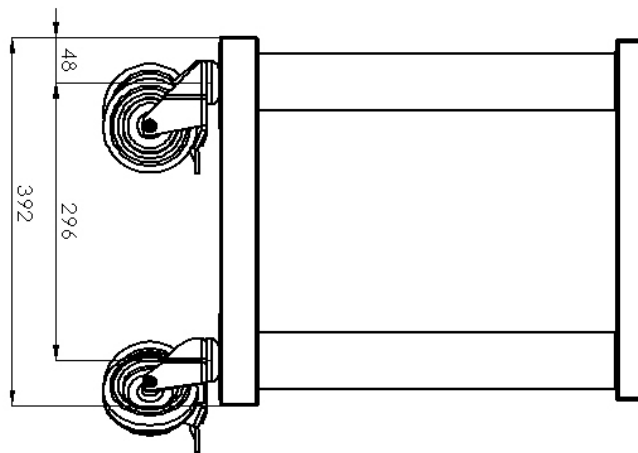
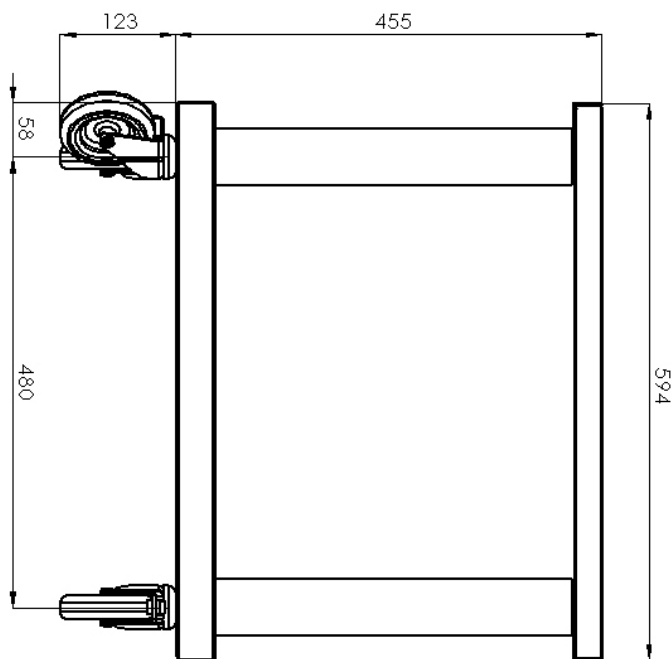

Technical data sheet



Technical parameters

Open stand mobile

Model

SAP Code

00003160

1. SAP Code:

00003160

2. Net Width [mm]:

392

3. Net Depth [mm]:

578

4. Net Height [mm]:

594

5. Net Weight [kg]:

12.50

6. Gross Width [mm]:

410

7. Gross depth [mm]:

610

8. Gross Height [mm]:

620

9. Gross Weight [kg]:

13.00

10. Material:

Stainless steel

11. Adjustable feet:

No

12. Construction type of device 3:

Opened

13. Device properties:

Neutral

14. Construction type of device:

On wheels

15. Unit:

No